

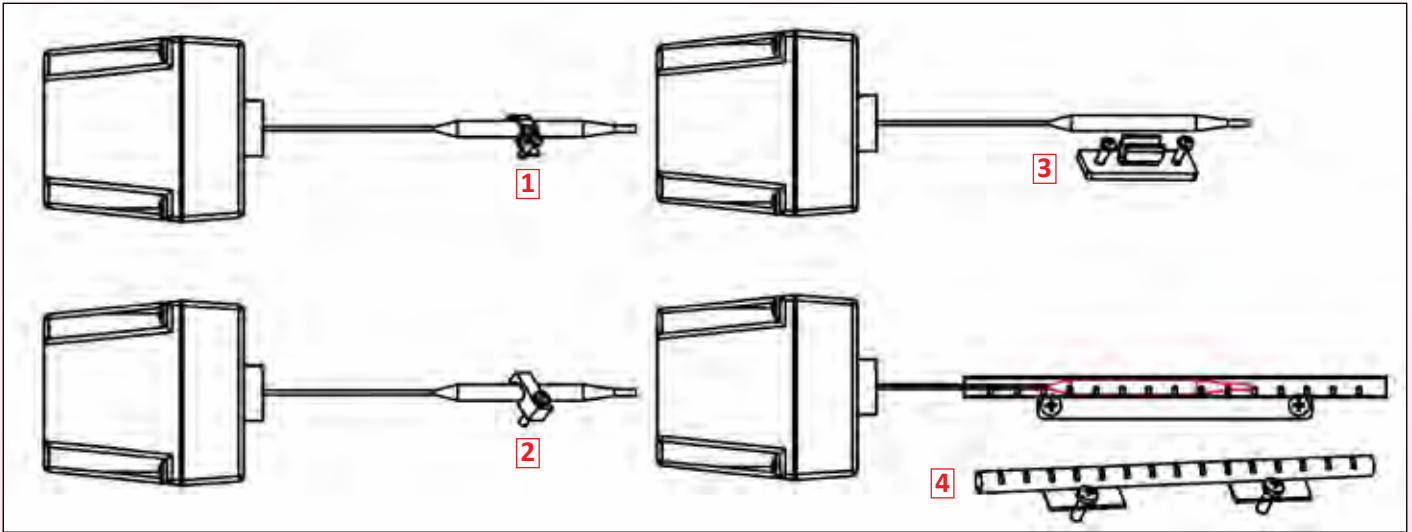

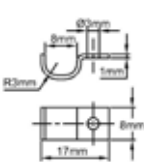



Bulb and Capillary surface mounting accessories

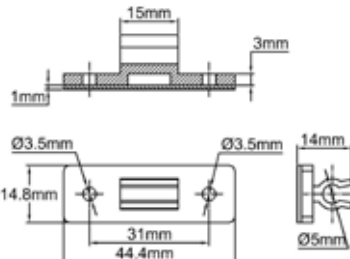
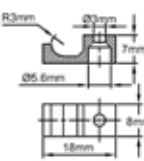
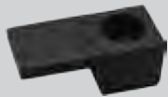
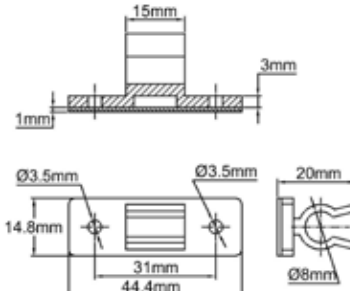
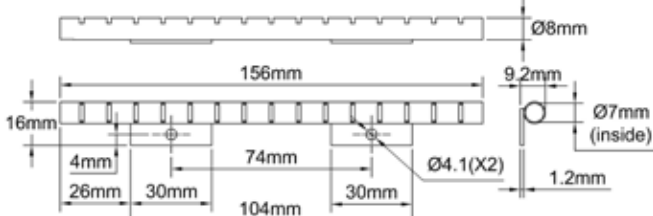
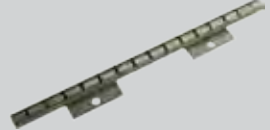

	<p>1</p>  <p>Bulb mounting clips Stamped steel, for bulbs dia. 5 and 6mm</p> <p>Reference 66PA045000020</p>		<p>3</p>  <p>Bulb mounting clips PA66 Plastic, 2 screw mounting or adhesive, for bulbs dia. 5 and 6mm, maximum temperature 80°C</p> <p>Reference 9BBFPM134211900</p>
	<p>2</p>  <p>Bulb mounting clips Reinforced PC-ABS, screw mounting, for bulbs dia. 5 and 6mm, maximum temperature 90°C</p> <p>Reference 9BBAE10000AFS07A</p>		<p>3</p>  <p>Bulb mounting clips, PA66 Plastic, 2 screw mounting or adhesive, for bulbs dia. 8mm., maximum temperature 80°C</p> <p>Reference 9BBFPM124211900</p>
			<p>4</p>  <p>Bulb protective mounting bracket, stainless steel, 2 screw mounting, for bulbs dia. 5 and 6mm</p> <p>Reference 66DU</p>